



MASSEY FERGUSON



MF 7S

155-220 HP

**A STRAIGHTFORWARD AND
DEPENDABLE FARMING EXPERIENCE**



MF 7S

The ultimate tractor in the fields

“The new MF 7S employs the latest straightforward and dependable technology designed to deliver ultimate efficiency and low operating costs.”

The MF 7S continues Massey Ferguson's promise to deliver highly dependable, straightforward, low maintenance tractors which provide efficiencies across all farming operations to increase your farm's profits.

Specifically designed to meet the needs of farming professionals, whatever your business and operations, the MF 7S is ideally suited for use in a range of applications from mixed farming to arable and contracting businesses.

Available with a wide choice of engine powers, transmissions, cab specifications, hydraulics and PTO options, you can tailor your MF 7S to precisely match your needs.

On the MF 7S, the engine, the transmission, the steering, the PTO and the hydraulics work together in perfect harmony to complete your farming tasks efficiently. This partnership offers easy and precise operation when driving on the road and manoeuvring in the field and farmyard.

With several models to choose from, the MF 7S is always the best choice.

MF 7S

POWERFUL DESIGN TO INCREASE PRODUCTIVITY

The face of the new MF 7S captures and holds your attention. At its centre is the iconic MF triple triangle logo, around which flows the powerful shape of the MF bar lights and the new MF grey sabre. Inspired by Massey Ferguson's heritage, it shares this striking livery with the award winning MF 8S.

Six-cylinder AGCO Power engines combined with Dyna-6 or Dyna-VT transmissions deliver productivity with EPM extra power for when it's most needed, helping you get the job done more efficiently.

The latest smart farming technology, including from ISOBUS, MF Guide, MF Rate and Section Control, combine to ensure you make the most of this sophisticated tractor, while improving comfort and ease of use for the operator.

THE NEW MF 7S WITH ITS POWERFUL NEW STYLING AND NEW FEATURES IS DESIGNED TO CAPTIVATE YOU FROM THE START AND BE THE ULTIMATE PERFORMER IN THE FIELDS.

MADE FOR SMART FARMING & CONNECTIVITY



8 LIVE FOR COMFORT

MADE TO MAXIMISE UPTIME
A NEW ERA OF SERVICES & CUSTOMER SUPPORT



26 MADE FOR PERFORMANCE
ENGINE POWER EFFICIENCY

28 HIGH EFFICIENCY TRANSMISSIONS

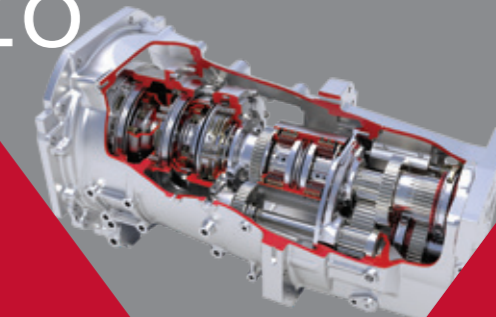

- The ultimate tractor in the fields 3
- Your MF 7S at a Glance..... 6
- Live for Comfort..... 8
- Made for Comfort – The Essential Version..... 14
- Made for Comfort – The Efficient Version..... 16
- Made for Comfort – The Exclusive Version 18
- Made for Smart Farming & Connectivity 20
- Made for Performance – Engine Power Efficiency..... 26
- High Efficiency Transmissions 28
- Made for Versatility & Traction..... 34
- Made For Hard Work – Hydraulics and PTO 36
- Made to Maximise Uptime – A new Era of Services & Customer support..... 42
- Make the MF 7S as individual as your farm – Options & Specifications 48

YOUR MF 7S AT A GLANCE

Designed for ultimate efficiency, the MF 7S is equipped with the latest straightforward and dependable technology to deliver low operating costs.

Efficient drive-lines, meeting Stage V emissions with advanced All-in-One system, low fuel consumption, long service intervals, impressive traction and lift capacities, together with low maintenance costs – the MF 7S simply makes your farming business more profitable.

WITH FOUR MODELS TO CHOOSE FROM, THE MF 7S IS ALWAYS THE BEST CHOICE

| | MF 7S.155 | MF 7S.165 | MF 7S.180 | MF 7S.190 |
|--|--|-----------|-----------|-----------|
| Engine | AGCO Power – Stage V – All-in-One technology | | | |
| Engine capacity | 6-cylinder, 6.6 litre | | | |
| Transmission | Dyna-6 | | | – |
| | Dyna-VT | | | |
| Maximum Power | 155 | 165 | 180 | 190 |
| Maximum Power with EPM (hp) | 175 | 185 | 210 | 220 |
| Maximum Torque @ 1,500 rpm (Nm) | 700 | 725 | 750 | 850 |
| Maximum Torque @ 1,500 rpm with EPM (Nm) | 750 | 800 | 860 | 925 |

Ultimate comfort for a more productive working day

- ▶ Cab and front-axle suspension improve driving comfort, while the colour dashboard display offers better visibility throughout the working day.
- ▶ A choice of four specification levels will meet your every need.
- ▶ The new armrest provides best in class controls and ergonomics.
 - ▶ Up to 16 LED work lights.

Low cost of operation

- ▶ 'All-in-One' Stage V SCR system cuts ownership costs and improves visibility.
 - ▶ Easy access for daily maintenance.
- ▶ 600 hr engine service intervals – to reduce costs and downtime.
 - ▶ MF Care Repair and maintenance contracts schemes.

Efficient drive-lines bring higher productivity

Dyna-6 Super Eco semi-powershift and Dyna-VT transmissions with Engine Power Management deliver more power when it is needed most. Perfect engine/transmission combinations deliver maximum outputs.

Straightforward, smart, sustainable farming technologies. New Datatronic 5 and optional Fieldstar 5 terminal provide the latest user friendly precision farming package

- ▶ 9" touchscreen terminal created to provide a more intuitive and precise farming experience.
- ▶ New MF Guide solutions provide economy by reducing overlaps.
- ▶ MF Section and Rate Control allows you to adjust the application rate on the go, whilst automatically minimising overlap, skips and wasted product.
- ▶ MF TaskDoc Pro creates and sends securely detailed records of jobs to the office and preferred partners through the secured Agrirouter cloud.
- ▶ MF Connect telemetry enables remote and near real time monitoring and decision making, improving efficiency and maximising uptime.

Ability to work faster with the most demanding implements

Up to five spool valves to the rear and three to the front, including front linkage, and Power Beyond installation, plus a high lift capacity hitch. The hydraulic system offers the ability to work faster with the widest implements while increasing versatility.

VIRTUAL REALITY



USE YOUR SMART PHONE TO STEP INSIDE THE MF 7S



◀ STEP 1

Use a QR code reader app. Download it for free from App Store or the Google Play Store.



◀ STEP 2

Open the app and scan this QR code...



◀ STEP 3

...and step inside your Massey Ferguson tractor.

Live the eXperience in 2D, moving your smartphone around in all directions or using your fingers.



◀ STEP 4

Live the full VR 3D Experience by clicking on the dedicated icon and use in combination with a pair of VR glasses.



LIVE FOR
COMFORT



THE CAB

WELCOME TO YOUR 'FIELD OFFICE'

From the origins of modern tractor design, the Massey Ferguson cab has been renowned for excellence, and the MF 7S moves that legacy a step forward. It's something we work hard for, so you can sit and reap the benefits when days go on and on, in a very productive environment that blends comfort, quietness, ease of use and quality.

Ergonomics – Everything you need in one place to make the working day go smoothly. Easy access to the cabin and all major controls conveniently to hand on the right armrest.

Efficiency at work – Boosting productivity, saving time and making the difference. Work smarter with implements and drive safely on the roads with 360° cab visibility.



4 SPECIFICATIONS

Essential, Panoramic, Efficient, Exclusive –
to suit all needs and applications



VISIBILITY

for enhanced efficiency, comfort and safety



EASY TO USE

with a logical layout and new armrest offering
comprehensive control

MADE FOR OPERATORS

THE BETTER EQUIPPED A TRACTOR IS FOR THE JOB IN HAND, THE **EASIER AND MORE EFFICIENTLY** THE JOB CAN GET DONE.

This is another area where the MF 7S really stands out of the crowd: as well as an extensive standard equipment package, it comes with a choice of different cab environments offering a wide range of equipment, giving you all the options that you need.

“ Whatever your operations, make the tractor your own ”



MADE FOR COMFORT

AND THERE IS MORE IN IT FOR YOU!

ALWAYS CONNECTED - Two USB ports and adjustable phone and tablet holder available through AGCO Parts.



BLUETOOTH RDS/MP3 RADIO is fitted as standard allowing hands-free calls. Optional phone and data radio controls through the Datatronic 5.

NEW DASHBOARD WITH SIS – SET UP AND INFORMATION SCREEN. Operators will appreciate the slim dashboard, which clearly displays operating data on its 70 mm x 52 mm, colour 'Set up and Information Screen'.



EASY AND SECURE ACCESS. Large wide door, steps, rails and tiltable steering column provide best-in-class accessibility to the cab.



MADE FOR COMFORT

CHOOSE THE ROOF TO SUIT.

A choice of three roof types allows you to tailor your MF 7S to offer improved visibility for all applications or to increase natural ventilation: you can choose between Standard roof, Standard roof with hatch and Visio roof.



The addition of the **16 LED WORKING LIGHTS** option transforms night into day with its outstanding brightness capacity. This package also includes daytime running LED signatures, enhancing an already very attractive design.

SIDE MIRRORS feature an adjustable top and lower section offering the best view during transport and reduce blind spots. Options include: electric de-icing and electronically adjustable mirrors.



CAB SUSPENSION brings extra comfort. Two types of cab suspension are available - mechanical and active mechanical. Both systems offer unprecedented levels of cab comfort.

NOW PLEASE TAKE YOUR SEAT AND ENJOY YOUR COMFORTABLE WORKING DAY ▶

Massey Ferguson offers the best-in class seat depending on models and options providing outstanding comfort.



HEADLAND MANAGEMENT is available via the Datatronic 5 on the Exclusive version (optional on Efficient version)...



...and controls are easily accessible on the armrest.



ESSENTIAL VERSION

Standard air suspended, swivel seat, with headrest, longitudinal shock absorber and mechanical lumbar adjustment.



EFFICIENT VERSION

Standard automatic air suspended, swivel seat, with headrest, longitudinal shock absorber and mechanical lumbar adjustment.



EXCLUSIVE VERSION

Standard automatic air suspended, swivel seat, with headrest, longitudinal shock absorber, heated and pneumatic lumbar.



OPTIONAL ON EFFICIENT AND EXCLUSIVE VERSIONS*

New automatic air suspended, swivel seat, ventilated, with two heating levels, pneumatic lumbar, longitudinal & lateral shock absorber, dual motion backrest and Dynamic Damping System (DDS).

*Not compatible with Visio roof

MADE FOR COMFORT

Essential is the entry-level for the MF 7S Series, but it is anything but basic.

It provides all the key elements you would expect from Massey Ferguson, with a blend of simplicity, ease of use and versatility to suit applications that require power and performance.

ESSENTIAL VERSION

THE NEW STANDARD FOR STRAIGHTFORWARD OPERATION

COMFORT & SAFETY

- STANDARD**
- Brake-to-neutral
 - Air-conditioning with manual adjustment
 - Telescopic, wide-angle wing mirrors
 - 2 USB ports
 - Standard air-suspended seat

- OPTION**
- Mechanical cab suspension
 - Suspended front axle
 - Panoramic cab with polycarbonate right-hand side window
 - Radio/ CD / MP3 Front Aux-in / Bluetooth with microphone
 - Automatic air-suspended seat

EFFICIENCY

- Control Centre with T-lever transmission operation
- Dyna-6 Super Eco with standard Automatic Mode
- Engine speed memory A
- Dyna-6 Super Eco 40 km/h Eco transmission*
- Closed Centre Load Sensing Hydraulics
- 3 mechanical spool valves

- Integrated Front Linkage System and PTO
- 540 & 1000, 540 Eco & 1000 Eco rear PTO
- Dyna-6 Eco 50 km/h transmission*
- Loader ready from factory with Multifunction mechanical joystick
- 4 mechanical spool valves

CONNECTIVITY

- MF Connect Telemetry-ready with 5-year subscription

- Fieldstar 5 terminal ISOBUS
- MF Guide system with Advanced guidelines
- MF Section & Rate Control
- MF TaskDoc & MF TaskDoc Pro recording all job's data exchange
- MF Next Management FMIS

* Depending on market/legislation



MECHANICAL MULTIFUNCTION LOADER JOYSTICK MAIN FUNCTIONS

- A Lift
- B Lower
- C Fill
- D Dump

COMBINED FUNCTIONS

- A/C Lift and fill
- A/D Lift and dump
- B/C Lower and fill
- B/D Lower and dump-bucket adjustment to horizontal position

THE ESSENTIAL PANORAMIC CAB OPTION

The MF 7S Series Panoramic cab offers unobstructed visibility to the right hand side for safe and efficient operation of side-mounted equipment.

The wide, one-piece polycarbonate screen is extremely tough and protects operators from flying debris. A special anti-scratch coating and dedicated wash/wipe system maintains great visibility in all conditions. For local authority and road work operations the cab can be equipped with fixing brackets and wiring for hazard warning lights and signs.

This cab option will allow a farmer/contractor to diversify his business into roadside maintenance contracting for local authorities.



- Light controls
- PTO Speed
- Rear linkage controls
- Safety light
- Ignition key
- Mechanical hydraulic lever
- Diff lock auto/manual
- 4WD auto/manual
- Side lights/low beam lamps
- Suspended front axle
- Brake to Neutral
- Rear and Front PTO Controls
- Rear linkage controls & depth wheel



MADE FOR COMFORT

Efficient is the medium specification package for the MF 7S Series, designed to help you work smarter and get better results.

Dedicated to delivering increased productivity thanks to its key features, the Efficient package enables you to work faster, to a higher standard, with more accuracy, together with high levels of comfort, ergonomics and reliability. Stay in control of the most technologically advanced and demanding implements to take advantage of their increased productivity.

EFFICIENT VERSION

ADVANCED EQUIPMENT TO HEIGHTEN YOUR EFFICIENCY AT WORK

| | COMFORT & SAFETY | EFFICIENCY | CONNECTIVITY |
|-----------------|---|---|--|
| STANDARD | Suspended front axle Mechanical cab suspension Air conditioning with manual adjustment Telescopic, wide-angle wing mirrors Armrest with new MultiPad lever Radio/ CD / MP3 Front Aux-in / Bluetooth with microphone and controls in armrest 2 USB ports Automatic air-suspended seat | Dyna-6 with Automatic Mode or Dyna-VT 40 km/h Super Eco transmissions Cruise Control and Brake-to-Neutral Closed Centre 110 l/min hydraulics Electrical and mechanical spool valves Engine speed memo A or B 2 electrical spool valves with electrical micro-joystick and 2 mechanical spool valves | MF Connect Telemetry-ready with 5-year subscription |
| OPTION | Mechanical active cab suspension Automatic Air Conditioning 16 LED working Lights SpeedSteer Heated, electric-adjust mirrors Automatic air suspended swivel seat, with lateral suspension, Dynamic Damping System | 50 km/h* Dyna-6 Eco with Supercrawler or Dyna-VT Integrated Front Linkage System and 1,000 rpm front PTO Loader-ready from factory with Multifunction Electrical joystick Closed Centre Load Sensing hydraulics with 150 or 190 l/min SpeedSteer | Datatronic 5 touchscreen terminal 9" (With Tractor settings management & ISOBUS integrated, and as an option, radio & phone interface, MF E-Loader, camera & MF Guide compatible) Fieldstar 5 terminal ISOBUS MF Guide system with Advanced guidelines MF Section & Rate Control MF TaskDoc & MF TaskDoc Pro recording all job's data exchange MF Next Management FMIS |

* Depending on market/legislation



EFFICIENT ELECTRO HYDRAULIC MULTIFUNCTION JOYSTICK

- A Lift front linkage or rear valve control +
- B Lower front linkage or rear valve control -
- C Front or rear valve control +
- D Front or rear valve control -



MADE FOR COMFORT

Exclusive is a combination of high-spec versatility and refinement dedicated to operators looking for a tractor with advanced features and functions in terms of ergonomics, comfort, automation, Smart Farming capacities and full connectivity.

This version is aimed at more intensive, large scale operators looking for more advanced features that will ensure cost-effective benefits for their business. The Exclusive armrest comes with numerous benefits including comfort and convenience when operating multiple, frequently-used controls.

Exclusive also adds the Datatronic 5 as standard. Use the 9" touchscreen terminal to manage tractor functions, ISOBUS capability to simplify implement operations and use of MF Smart Farming solutions for Agriculture 4.0.

Using the Exclusive package, operate the most technologically advanced and demanding implements with the optimum efficiency to take advantage of their increased productivity.

EXCLUSIVE VERSION

THE ULTIMATE EXPRESSION OF PRODUCTIVITY AND INNOVATION

COMFORT & SAFETY

STANDARD

- Suspended front axle
- Mechanical active cab suspension
- Automatic Air Conditioning
- Heated, electric-adjust mirrors
- Radio/ CD / MP3 Front Aux-in / Bluetooth with microphone and controls in armrest
- Automatic air suspended, swivel seat, with longitudinal shock absorber and pneumatic lumbar

OPTION

- Automatic air suspended swivel seat, with lateral suspension, Dynamic Damping System
- 16 LED working lights

EFFICIENCY

- All controls in the ergonomic armrest with new MultiPad lever
- 4 electrical spool valves with electrical micro-joystick and fingertips switches
- Dyna-6 Super Eco with automatic mode or Dyna-VT transmission
- Cruise control and Brake-to-Neutral
- Closed Centre 110 l/min hydraulics

- Integrated Front Linkage System and 1,000 rpm front PTO
- Up to 8 electrical spool valves fully configurable and customizable on the Exclusive armrest
- SpeedSteer
- Loader-ready from factory with Multifunction electrical joystick

CONNECTIVITY

- Datatronic 5 touchscreen terminal 9" (With Tractor settings management & ISOBUS integrated, camera & MF Guide compatible)
- MF Connect Telemetry-ready with 5-year subscription

- MF Guide system with Advanced guidelines
- MF Section & Rate Control
- MF TaskDoc & MF TaskDoc Pro recording all job's data exchange
- MF Next Management FMIS
- Fieldstar 5 terminal
- Radio & Phone interface, MF E-Loader management via the Datatronic 5 touchscreen terminal 9"



EXCLUSIVE ELECTRO HYDRAULIC MULTIFUNCTION JOYSTICK

- A Lift front linkage or rear valve control +
- B Lower front linkage or rear valve control -
- C Front or rear valve control +
- D Front or rear valve control -



Forward control
 Customisable Functions
 Reverse control
 Proportional spool valve control
 Fourth hydraulic function
 Increase or decrease speed

Fieldstar 5 terminal
 Datatronic 5, 9" terminal
 Light controls
 PTO Speed
 Rear Linkage Controls
 Safety Lights
 Ignition Key
 Side lights / low beam lamps
 Suspended front axle / Brake to Neutral / ISB / Fast Steering
 Fingertips hydraulics
 USB

MADE FOR SMART FARMING & CONNECTIVITY

The New MF 7S range has taken Smart Farming and connectivity to new heights.

The MF 7S range features the latest standard Connective Package, which comes with Real Time Information and Remote Service. What's more, it comes with a new and more intuitive Datatronic 5 interface as well as with the Fieldstar 5 terminal to control Smart Farming and Agriculture 4.0 features such as: MF Guide, MF Section and Rate Control as well as data transfer and management through MF TaskDoc and TaskDoc Pro.

“ We run our operations with the very latest technology and need to reduce inputs as well as using excellent data management facilities. ”



DATATRONIC 5

Powered by Fuse® Smart Farming Solutions



Full tractor functions management and optimisation features such as transmission, engine and hydraulics. Moreover there is the remarkable Dual Control system providing excellent control of semi-mounted ploughs by automating the furrow entry and exit. At the same time the system adjusts the plough's depth wheel in relation to the rear linkage.

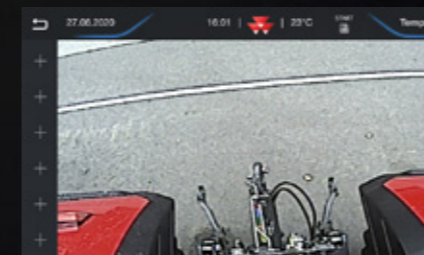

Video Mode* – Pictures from the on-board camera can be displayed on the console screen, allowing operators to monitor complex implements or simply improve safety and efficiency when reversing.

*Image for illustration purpose only



Headland management settings – The Datatronic 5 comes as standard with the most intuitive, straightforward and easy to use automatic headland management system available in the market. It is designed to save you significant time at headlands, allowing you to concentrate on the operation in hand so that you can maximise outputs with ease.



The new MF E-Loader auto-control function helps to increase loading accuracy, productivity and safety. It enables operators to weigh individual fork or bucket loads. It also records the total weights of each item, load or job and these can be transferred as a simple spreadsheet. Operators can also set-up and save automatic sequences for different loading cycles. MF E-Loader also provides a useful bucket shake facility.



ISOBUS for total implement control – ISOBUS allows an implement manufacturer's control system to be displayed on the terminal screen, saving owners and operators time and money, with no need to install additional monitors in the cab. Simply plug the implement lead into the tractor's ISOBUS socket and the system automatically uploads the operating menus and displays on the screen.



ISOBUS MultiPad switch assignment - ISOBUS implements can be controlled directly using the MultiPad lever. Having all controls (tractor and implement) on the same lever is a lot more convenient than using additional displays and levers.



Memorise data and settings – Unlimited number of user settings configurations enable the system to record information during operation on area worked, fuel use, hours worked and much more. All the settings and parameters can be stored by the Datatronic terminal, and can then be recalled to find the previous setting that was used on a tractor.



Access to radio functions via Datatronic 5: the same as you would in a car, simply connect devices via Bluetooth, USB or aux control with the option of synchronising more than one smartphone. Memorise radio stations, receive and make calls, and other functions.



MADE TO KEEP YOU ON TRACK

MF Guide is Massey Ferguson's full featured, hands-free steering system. MF Guide is capable of delivering sub-metre, decimetre and centimetre accuracy, increasing the efficiency of your farming operations.



CHOICE OF RECEIVERS & CORRECTION SIGNALS

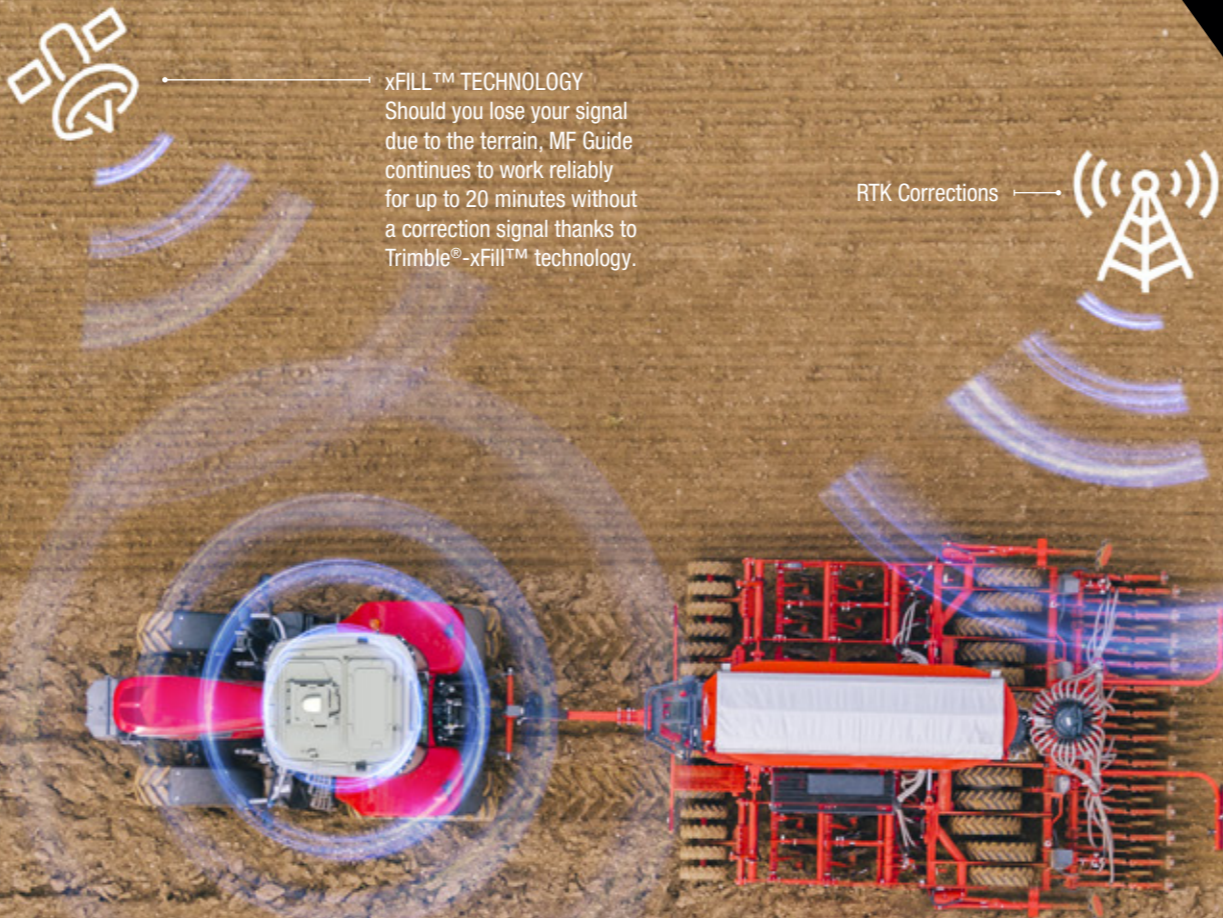
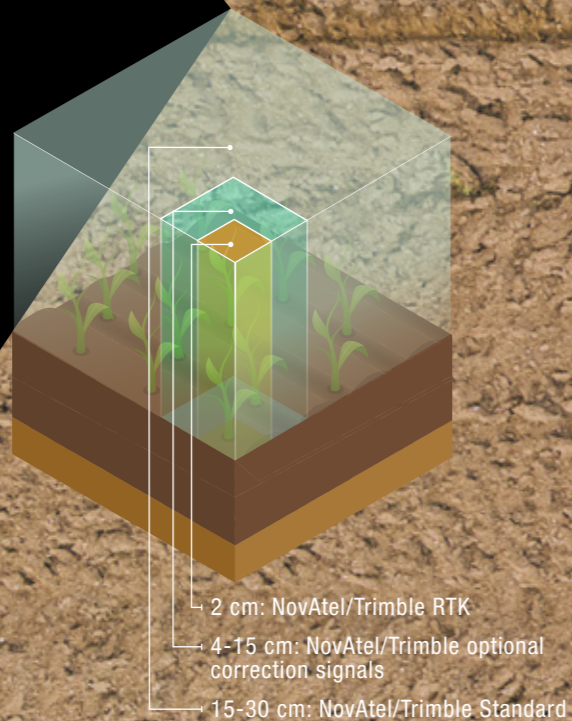

With the new Massey Ferguson MF Guide, there are now two different receiver systems available: NovAtel® and Trimble®. Existing Trimble® RTK infrastructures on the farm, such as NTRIP, can continue to be used. Talk to your local Massey Ferguson Dealer or Distributor to find out more.

EASY, FAST SET-UP WITH GO MODE FUNCTION

Starts up within 5 minutes, even for first time users. This allows the operator to begin working with auto-guidance/steering for the first time in three easy steps...

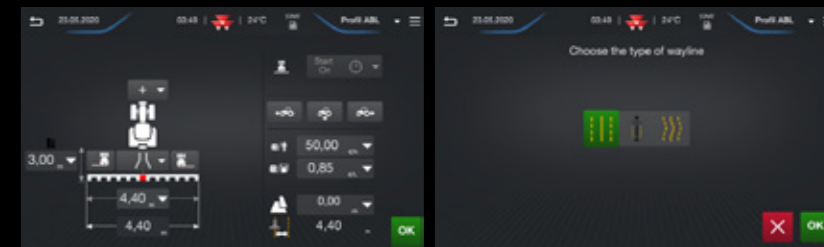

KEY BENEFITS FOR YOU



12% FUEL SAVING

Guidance systems are proven to save up to 12% fuel in field operations.

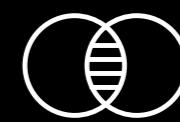

NO OVERLAPS

MF Guide virtually eliminates overlaps.



SAVINGS

Using MF Guide helps you save money by reducing overlaps, precision application and increasing efficiency.



COMFORT

Using MF Guide helps to reduce fatigue and stress by guiding you efficiently through your working day.



MFsection control

FUSE SYNCHRONISED

MF Section Control is the new Precision Farming solution from Massey Ferguson providing the most advanced and most efficient Section Control feature managing up to 36 sections and 5 applications. With the fully automatic Section Control for ISOBUS implements, operators can apply seeds, fertilizer or pesticides without overlapping. This prevents double treatment and areas worked outside of the field edges. With the aid of the straightforward and easy to use Section Control assistant, the operators can set the correction values for each implement, quickly and easily. The system uses the tractor's GPS system to automatically turn on and off individual sections in areas that have already been covered which automatically results in economical application and enhanced yields.



MFrate control

FUSE SYNCHRONISED

Variable application with Variable Rate Control (VRC)
Data transfer with TaskDoc™ Pro now permits variable rate application, based on the needs of the soil or plants, and therefore saves operating inputs. The individual requirements for seeds, fertiliser and pesticides are shown on application maps. They are then called up during operation and automatically executed. The big advantage: operating inputs can be defined and planned with the aid of the field database and then applied with utmost precision. For example, you can tailor chemical or fertiliser application in areas as required, lowering input cost and further enhancing yields.

MF TASKDOC & AGRIRouter: NEXT MACHINE MANAGEMENT

MFtask doc

FUSE SYNCHRONISED

Information is power, with accurate data measurement and recording enabling more precision in decision making. The new TaskDoc™ system has a place in the future of agriculture, helping farmers to become more productive through the knowledge brought by putting precision-measured data at the business owner's fingertips.

With **TaskDoc™** all jobs' data can be recorded with a minimum of effort, documented in the field record and then analysed, all in the shortest amount of time. The data is transferred via USB Stick from the Datatronic 5 terminal to the office using the ISOBUS standard TC-BAS. Data on the quantity of seeds and fertiliser applied or the fuel consumption is available immediately after the work is done.

The **TaskDoc™ Pro** version, also enables recording of the GPS position data and data transfer in real-time via mobile through the secured Agrirouter Cloud service. This makes automatic, seamless exchange with ISOXML-capable field management software and mapping possible including in MF Next Management FMIS. The data for the operating inputs that have been used are transferred and can also be monitored through the Datatronic 5 terminal while working.



AGRIRouter



This universal data exchange platform lets you connect machinery and your Farm Management Information System (FMIS), regardless of vendor or manufacturer. You can also determine who to exchange data with, and to what extent. Agrirouter is your ticket to the digitalization of agriculture, enabling you to retain control of your data.

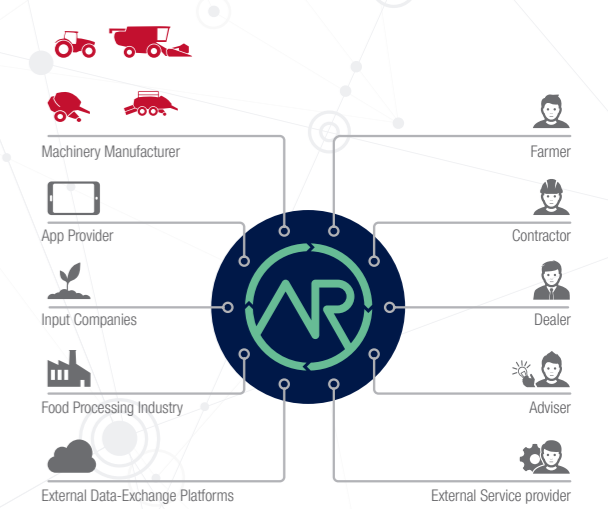

MADE FOR PERFORMANCE

THE PURE EXPRESSION OF POWER EFFICIENCY

The new MF 7S teamed up with the most mature engine SCR technology on the market, the undisputed sustainable leader in heavy duty farming operations delivering class-leading power and torque, with best-in-class total cost of ownership.

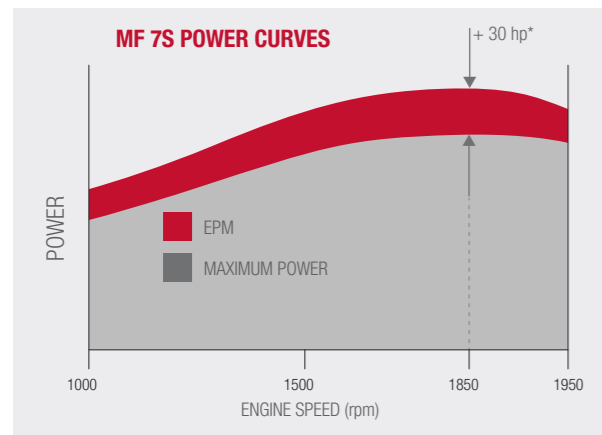
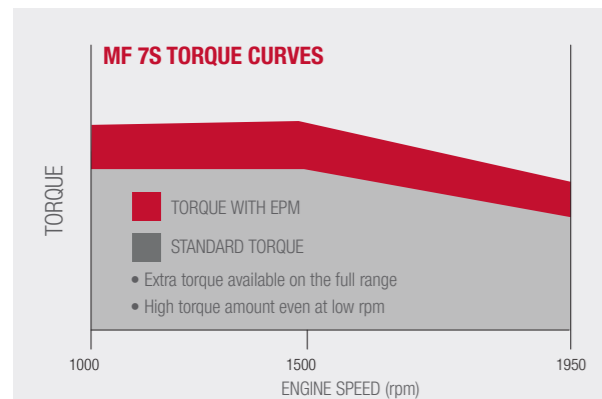

Combined with the **HIGHLY EFFICIENT DRIVELINES**, the engine is consistent and reliable, saving fuel, increasing efficiency and cutting costs



-40%
Particle reduction versus the previous stage

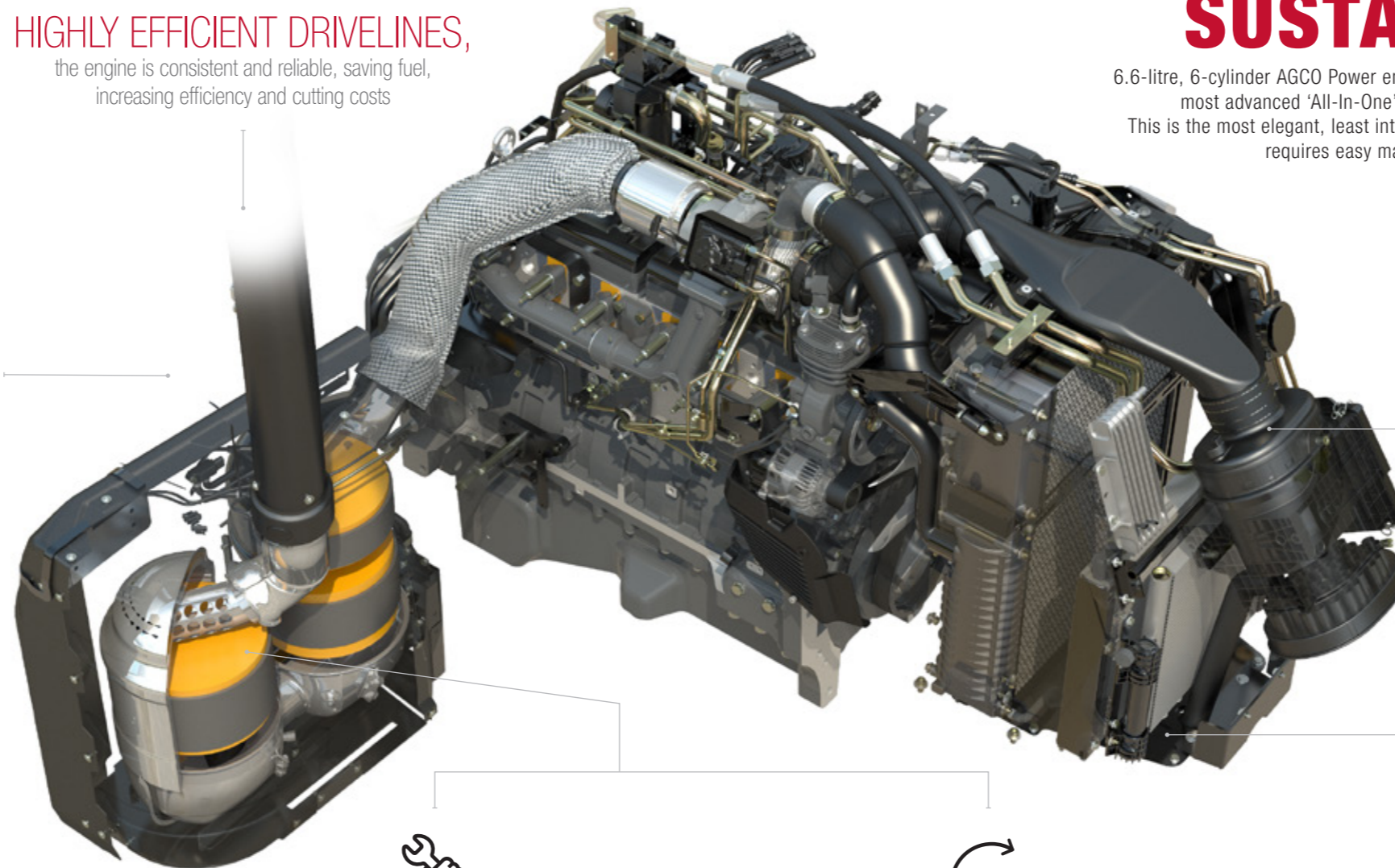

600 H
Long service intervals reduce running costs



NO COMPROMISE
The compact All-in-One emission control system is tucked neatly under the cab, where it has no impact on visibility

EFFICIENT SUSTAINABILITY

6.6-litre, 6-cylinder AGCO Power engines employ Massey Ferguson's exclusive, most advanced 'All-In-One' system to meet strict emission regulations. This is the most elegant, least intrusive option that does not impede visibility, requires easy maintenance and helps improve fuel economy.



FUEL SAVINGS
by lower engine revs



LOW NOISE

EPM

EPM OFFERS UP TO 30 HP MORE WHEN IT IS MOST NEEDED.

This means your MF 7S responds automatically to the load imposed on it, and adjusts fuelling accordingly to give you extra power. Designed to tackle tough transport and PTO work challenges, advanced electronic engine and transmission management makes more power automatically available under load or at speed.

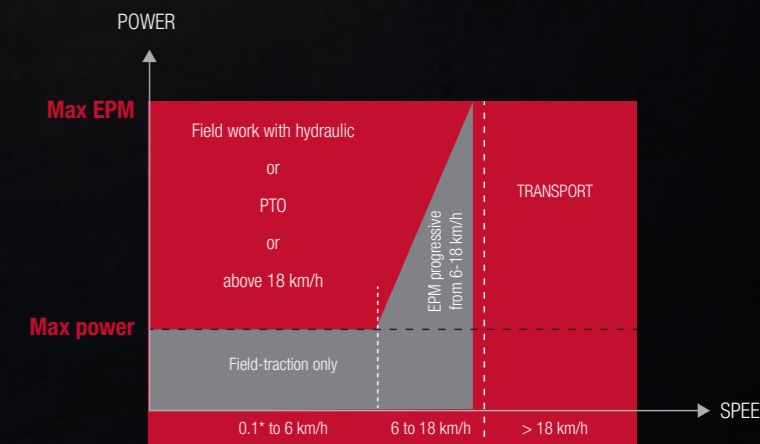

HIGH EFFICIENCY TRANSMISSIONS

WHEN IT COMES TO DRIVE POWER, WE'VE REALLY SHIFTED UP A GEAR AT THE SPEED OF MIND

Whether your workload demands a semi-powershift or continuously-variable transmission, MF 7S tractors can be specified with the format that fits your farm. Dyna-6 offer six powershifts in each of four ranges, which can all be controlled from the armrest joystick, the transmission control lever or the MultiPad lever (depending on model).

The unique MF Power Control lever on the left side of the steering column provides a PowerShuttle feature, as well as an alternative method of transmission ratio changing and a de-clutch function. Shuttle response can be adjusted according to operator preference.

Massey Ferguson's Dyna-VT Continuously Variable Transmission continues to be one of the most popular transmissions offering maximum productivity, efficiency and operator comfort.

Easy to use. Smart to operate. Efficient and comfortable.

MADE FOR CONTROL

“Control in the palm of your hand.”

The MultiPad lever operates the transmission as well as controlling cruise control, the rear linkage, PTO, headland management and spool valves through the integrated micro-joystick. All operations are easily to hand for greater comfort.



POWER CONTROL LEVER

Exclusive, simple, the unique Massey Ferguson Power Control lever provides straightforward three-in-one operation.



- YOU CAN:**
- shuttle between forward /reverse
 - shift speeds and ranges: up and down
 - de-clutch
 - select neutral

LEAVING YOUR RIGHT HAND FREE TO OPERATE A LOADER OR ANY IMPLEMENT HYDRAULICS.

DYNA-6

The semi-powershift transmission

PERFORMANCE, REFINED.



Delivering class-leading **dynamic performance and reliability**, the semi-powershift transmission provides six Dynashift ratios, perfectly spaced in four ranges and changed without using the clutch pedal.

Dyna-6 Super Eco offers six powershift steps in four ranges for ease of operation in the field and on the road. A total of 24 speeds in both directions means there's a match for virtually every operation, with top transport speeds of either 40 km/h or 50 km/h* achieved at low engine speeds.

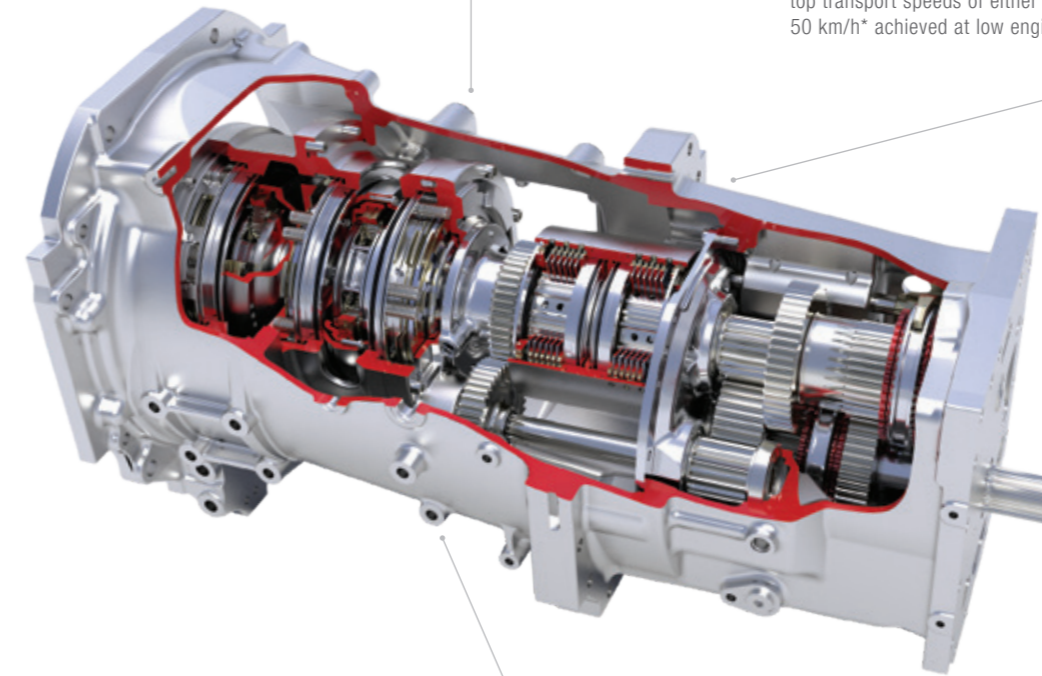

Automatic mode is standard on all MF 7S tractors with Dyna-6 transmissions. This advanced control automatically selects the correct ratio to suit the engine load and prevailing conditions.

Automatic mode's standard feature helps cut costs, with maximum speed achieved at a very low engine speed to save fuel (40km/h @ 1,500rpm, 50km/h @ 1,800rpm, depending on tyres).

◀ **Dyna-6 Super Eco** provides six Dynashift changes in each range, offering 24 forward and 24 reverse speeds, with an excellent overlap and a total of nine speeds in the Field Working range.

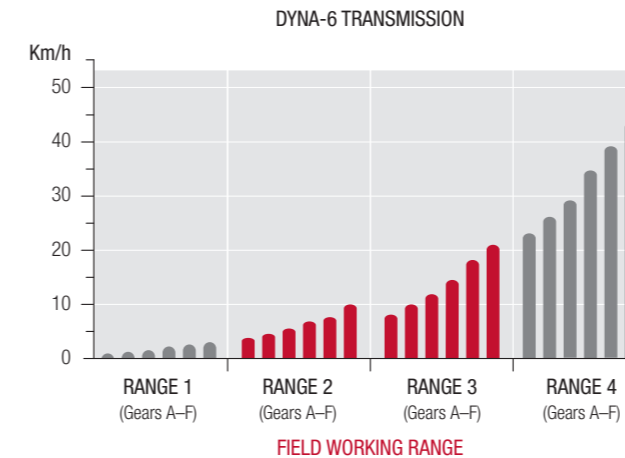

* Depending on market/legislation.

DYNA-6 BENEFITS AT A GLANCE

- ▶ 0.08 to 40 km/h or 50 km/h* with Supercreeper
- ▶ Maximum productivity with 24 forward and 24 reverse speeds, all changed without using the clutch
- ▶ Power Control lever offers three functions in one – forward/reverse shuttle, declutch and speed shifting
- ▶ Nine speeds in the Field Working Range
- ▶ Pedal mode Automatic mode with Automatic setting
- ▶ Brake-to-Neutral with direct activation disengages transmission with braking
- ▶ Supercreeper speeds as option (48x48)
- ▶ Super Eco as standard



24x24
Speeds

DYNA-VT TRANSMISSION

THE SMOOTHEST POWER DELIVERY, THE ULTIMATE IN PRODUCTIVITY.

Dyna-VT continuously variable transmissions are now equipped with a new Automatic mode. Simply activated with a switch on the armrest, auto mode allows the operator to adjust forward speed with the MultiPad lever or the foot pedal, while the engine speed is automatically regulated according to the load and speed. The hand throttle now also sets a lower engine speed limit – with rpm never dropping below this limit.

The Super Eco version of the Dyna-VT reduces fuel consumption by achieving 40 km/h at just 1,450 rpm.



DYNA-VT BENEFITS AT A GLANCE

- ▶ Stepless transmission brings complete operator's comfort and optimum fuel efficiency at all times
- ▶ Simple, infinite speed control, from 0.03 speeds to 40 km/h or 50 km/h* available with 40 km/h Super Eco or 50 km/h* Eco
- ▶ The choice of two speed ranges optimises torque for different applications
- ▶ Lever, pedal control means operator can choose his preferred mode
- ▶ 'Supervisor' maximises output under varying loads
- ▶ New Automatic mode enables operators to adjust forward speed, while automatically regulating engine speed according to load and speed
- ▶ Shuttle and Pedal aggressiveness adjustment with Brake-to-Neutral feature



INFINITE

Speeds from 0.03 km/h to 40 km/h or 50 km/h*



HIGH COMFORT

Stepless transmission

*Depending on market legislation.

ULTIMATE COMFORT. STEPLESS TRANSMISSION.

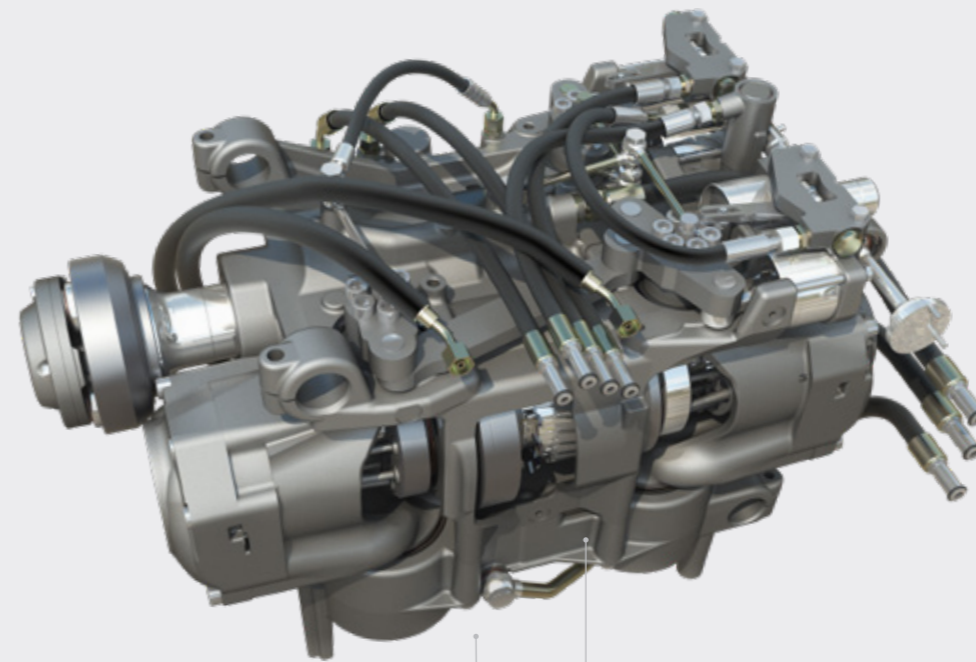

The 'Supervisor' is on continuous stand-by and activates when engine speed falls under load. The benefit of the 'Supervisor' is that even when the load on the engine is increased and engine speed drops, the transmission will automatically reduce forward speed to maintain total power, whether in PTO applications, field work or transportation. When used in conjunction with C1 and C2, which set a specified forward speed, the tractor will then operate at maximum output as load fluctuates as well as automatically adjusting the tractor back to the required speed.

The original Dyna-VT transmission is a true testament to precision engineering; guaranteed **productivity, complete operator comfort and optimum fuel efficiency** at all times. Further, consistent enhancements such as Automatic mode make it the most intuitive CVT transmission on the market.

AUTOMATIC MODE

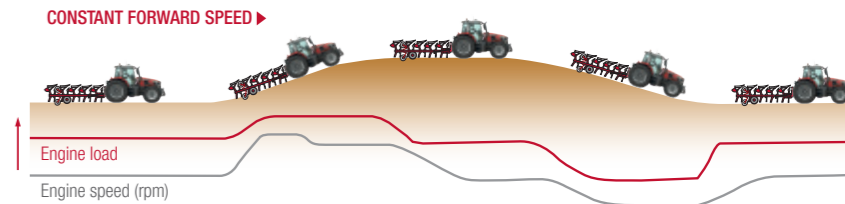

▲ The highly-regarded Dyna-VT continuously variable transmission now has a new Automatic mode. This allows operators to use the MultiPad lever or foot pedal to alter forward speed, while automatically setting the optimum engine speed according to the load and speed. As well as delivering smoother operation, it also improves fuel efficiency.

As the load (red line) changes according to varying conditions, the Dyna-VT automatically responds by adjusting the engine speed (grey line) to maintain the set forward speed. This optimises performance, saves fuel and reduces noise.

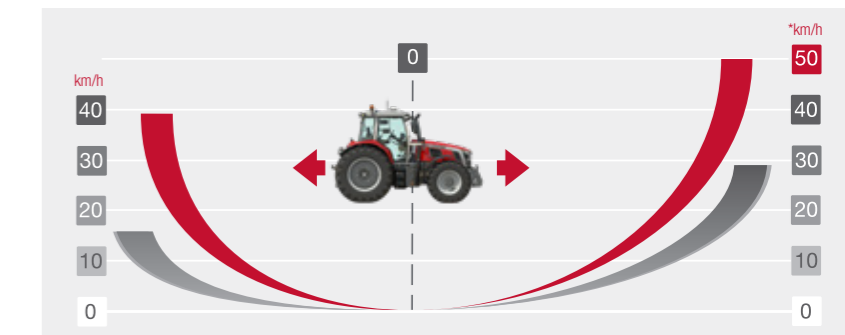

▲ **STEPLESS TRANSMISSION**
Dyna-VT is amazingly simple to operate and works extremely well in differing conditions. There's no shifting of gears, no jolts and no breaks in traction or power.

Simple, infinite speed control, from creeper speeds to 50 km/h*.

*Depending on market legislation.

MADE FOR VERSATILITY & TRACTION

Tractor power means nothing if it cannot be transferred to where it matters: the ground.

A wide choice of tyre dimensions and ballasting options available for the MF 7S offer improved traction with less soil compaction for lower operating costs and higher crop yields.

That is part of our commitment to help protect the soil and preserve the land for future generations.

PERFECT WHEELBASE FOR THE PERFECT POWER AND SOIL PRESERVATION.

Wheelbase length is 2.88 m offering improved stability with or without a heavy implement, maintaining high levels of traction in the field and increased comfort in transport.

The combination of the wheelbase and the MF 7S chassis design means that less ballasting weight is needed, ensuring maximum soil preservation and reduced ground pressure during cultivation, drilling and seeding.

“ Our land is heavy clay so minimising soil compaction is extremely important. ”

2.88 m

4.93 m
turning radius*

▲ BALLASTING FOR FLEXIBILITY

To deal with intensive traction work or counter ballast (front or rear), sometimes you need extra weight, so a wide choice of ballasts is available. The MF 7S is available from the factory with additional front and rear weights to exactly match your needs.

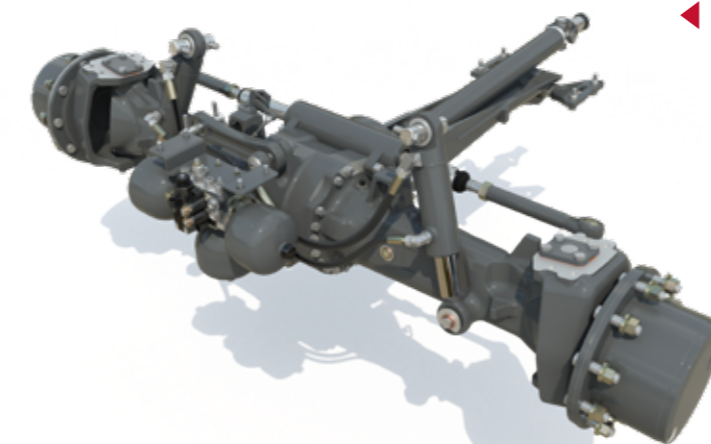

◀ FRONT AXLE SUSPENSION

Improved comfort and safety for transport applications and greater traction is delivered by an innovative front suspension option. The simple design produces superior ride comfort, turning angle and offers the full angle of oscillation as well as maximising ground clearance. The long 140 mm stroke provides the best comfort in the market.

* Track width 1.9 m

▲ MANOEUVRABILITY

Great manoeuvrability helps improve productivity when turning on the headland in the field as much as it does for loader operations or negotiating narrow roads. The sculpted chassis design and wasp-waisted bonnet deliver one of the best turning circles on the market, along with superb visibility.

SELECTING THE CORRECT BALLASTS & TYRES: BENEFITS AT A GLANCE

- ▶ More power to the ground
- ▶ Ultimate traction capabilities
- ▶ Lower soil compaction to boost yields whilst maintaining soil health for the next generation
- ▶ Improved fuel economy

▼ **SPEEDSTEER** reduces operator effort for faster operation on the headland or during loading operations using a front loader.

It enables the operator to adjust the steering ratio and select the number of turns of the steering wheel required for a given amount of steering angle turns.



MADE FOR **HARD WORK**

OUTSTANDING OPERATION AND PERFORMANCE TO TACKLE ANY TASK

Modern implements are placing more and more demands upon the tractors that power them, which are asked to perform faster and respond better. The MF 7S comes with immense capabilities to easily handle heavy-duty applications with outstanding lift and drive capacities for the very latest implements. The MF 7S is a tractor which is powerful, full of torque and nimble capabilities. Perfect if you are looking for a machine with unbeatable power take off, for outstanding operation and performance when working with the most advanced implements.



“ Hydraulic energy
to power the most
demanding tasks ”



MADE FOR HARD WORK

UP TO 190 LITRES/MIN

On MF 7S tractors with Dyna-6 Super Eco transmission, standard closed centre hydraulics offer a 110 litres/min load sensing system and 150 litres/min as an option.

For a dynamic hydraulic response, MF 7S Dyna-VT models are equipped with a 110 litre/min closed-centre load-sensing system as standard. Further hydraulic power and flow is delivered by the 190 litre/min load-sensing system, which is capable of operating the most demanding implements. This uses a variable displacement swash plate pump that supplies oil on demand – saving energy by providing only what is required. This enables the system to generate high flowrates at low engine speeds and maintain high output with economy.

| HYDRAULIC FLOW COMPATIBILITY (l/min) | LS: 110 | LS: 150 | LS: 190 |
|--|---------|---------|---------|
| MF 7S Dyna-6 (Essential) | ● | - | - |
| MF 7S Dyna-6 (Efficient and Exclusive) | ● | ○ | - |
| MF 7S Dyna-VT | ● | - | ○ |

● Standard specification ○ Optional - Not available
LS = Load Sensing



Up to **2** front spool valves and free return.



Up to **4,000 kg** lift capacity. A heavy duty Integrated Front Linkage System (IFLS) is available as an option and is designed to match the front PTO and loader subframe.



1,000 RPM front PTO is available.

Combined with the front linkage, it allows a wide range of additional implements to be powered: reducing passes and improving efficiency. Benefit from real time savings – more than doubling output when mowing grass.



ISOBUS socket connects compatible implements



Up to

4 PTO SPEEDS

A wide choice of PTO options are available with standard PTO speeds at 2,000 rpm, where maximum power is achieved. With the benefit of a 'constant power' band of up to 1500 rpm and the ability to precisely select any ground speed at the chosen engine speed, you can always achieve a perfect match of PTO speed, forward speed and power – with optimum economy. MF 7S Efficient and Exclusive versions are equipped with electrical PTO speed selection for convenience.



Up to

9,600 kg

lift capacity from heavy duty rear linkage with Ultimate Draft Control. MF's digital ELC system gives the highest standards of draft control with more accurate depth settings and better ground contour following. The result is more weight transfer, better traction, less wheelslip, reduced tyre wear and reduced fuel consumption whilst still maintaining greater output.

POWER BEYOND

BUILT INTO THE CCLS SPOOL BLOCK IS A POWER BEYOND FACILITY that via additional flow and return pipes provides oil flow directly from the pump, enabling additional remote spool valves to be connected.



Up to

5

rear spool valves and free return with decompression lever

OPERATE YOUR LOADER THE MASSEY FERGUSON WAY

When you buy a Massey Ferguson loader with your new MF 7S tractor, it can be specified fully MF loader-ready. Your tractor will come complete from the factory with the loader subframe, designed for maximum manoeuvrability and maintenance access, already built on so that it forms an integral part of the machine.

“ The beauty of this joystick means you can go from forward to reverse and operate the loader at the same time, without taking your hand off the steering wheel. ”

| | Non self-levelling | Self-levelling | | | | | |
|--|--------------------|----------------|------------|------------|------------|------------|------------|
| | | MF FL.4227 | MF FL.4323 | MF FL.4327 | MF FL.4621 | MF FL.4624 | MF FL.4628 |
| Model Compatibility | | | | | | | |
| MF 7S. 155-180* | ● | ● | ● | ● | ● | — | — |
| MF 7S. 190* | — | ● | ● | ● | ● | — | ● |
| Maximum Lift Height - Measured At Pivot Pin | m | 4.25 | 4.25 | 4.25 | 4.55 | 4.60 | 4.75 |
| Maximum Dump Angle At Maximum Height | | 57 | 57 | 57 | 53 | 54 | 51 |
| Maximum Rollback Angle At Ground Level | deg. | 48 | 48 | 48 | 52 | 49 | 57 |
| Lift Capacity To Maximum Height - 800 mm Pivot Pin | | 1,590 | 2,140 | 2,470 | 1,980 | 2,170 | 2,000 |
| Lift Capacity To 1.5 m Height - 800 mm Pivot Pin | | 2,110 | 2,350 | 2,700 | 2,110 | 2,460 | 2,280 |
| Breakout Force - 800 mm Pivot Pin | kg | 2,270 | 2,470 | 2,840 | 2,230 | 2,620 | 2,430 |
| Rollback Force At Ground Level - 800 mm From Pivot Pin | kg | 4,030 | 3,400 | 4,540 | 4,000 | 3,970 | 4,580 |
| Digging Depth | mm | 160 | 160 | 160 | 200 | 160 | 160 |

* MF FL 4227 / MF FL 4323 / MF FL 4327 must be specified with extended bearing box



TRACTOR/LOADER COMBINATION HIGHLIGHTS

- ▶ Fully integrated MF FL loader now available factory-fitted to deliver ultimate performance
- ▶ Multifunction joystick option also changes direction and speed, providing total control
- ▶ Proportional control of a third spool valve enables operators to open/close a grab and tip or crowd an implement at the same time
- ▶ Highest visibility thanks to the smart profiled design of the bonnet and the dashboard
- ▶ Unrestricted manoeuvrability and access for maintenance
- ▶ Visio Roof option with Falling Object Protection (FOPS)
- ▶ Excellent manoeuvrability including tight turning angles, SpeedSteer
- ▶ New Bucket Shake function on Multifunction joystick
- ▶ New quick coupling system reduces pressure losses at high flows, quicker loader movement and saves fuel
- ▶ Hydraulic implement locking can be activated via the SIS
- ▶ New, standard Engine Speed Automation on the SIS menu allows operators to increase the engine speed according to the action on the joystick
- ▶ To further improve loading performance, there is a range of output and comfort enhancing features including high flow hydraulics and the Brake to Neutral function, which also disengages drive when the brakes are applied
- ▶ New MF E-Loader available as an option to optimise the use of the loader and to measure loading tasks from the Datatronic 5 touchscreen



The unique Multifunction joystick option makes it easy to control the loader, also providing another shuttle option, as well as the ability to adjust the tractor speed. Grabs and other implements are also easily operated thanks to proportional control of the third spool valve, while tipping or crowding an implement at the same time.

LOADER OPERATION

Joystick main functions:

- A. Lift
- B. Lower
- C. Fill
- D. Dump
- E. Close
- F. Open

COMBINED FUNCTIONS:

- A/C. Lift and fill
- A/D. Lift and dump
- B/C. Lower and fill
- B/D. Lower and dump
- A/E. Lift and close grab
- A/D/F. Lift and open grab



MADE TO MAXIMISE UPTIME

ENHANCED TRACTOR OWNERSHIP EXPERIENCE & COMPLETE PEACE OF MIND



CONNECTED ANYWHERE. ANY TIME.

STANDARD WITH **5 YEARS**
SUBSCRIPTION.



Fix your costs and guarantee optimum performance for your MF 7S with MF Care.

MF Care Service and extended warranty contracts are flexible to suit your payment and operating hours requirements. Regular servicing provides preventive maintenance – picking up any faults before they become a problem, which helps reduce downtime. A full dealer service history using genuine AGCO Parts will also increase the residual value of the machine.

- ▶ Support maximum residual value of your tractor
- ▶ Flexible terms and long-term price packages
- ▶ Available up to 12 months from registration
- ▶ Experienced MF technicians available for on or off-site servicing

GREATER UP-TIME, OPTIMISED MAINTENANCE AND SMARTER SERVICES WITH MF CONNECT.

OWNER, DEALER AND TRACTOR ARE 100% CONNECTED!

MF Connect is a fleet monitoring system, that allows customers to keep a close eye on their Massey Ferguson machines.

Viewing machinery operations and equipment operating parameters in virtually real time on their mobile phone, tablet or desktop computer has never been easier.

This enables owners and managers to manage operations more effectively, helping to improve operating efficiency with remote diagnostics, ensuring optimum uptime.

| | SILVER | GOLD |
|----------------------|---|---|
| DETAILS | REGULAR MAINTENANCE CONTRACTS The Service Package includes all prescribed maintenance work on the basis of fixed prices. | REPAIR CONTRACTS Extended warranty contracts which offer security against repair costs (except wear). Tariffs with or without excess available as an option. |
| MACHINE TYPE | All | All |
| REGULAR MAINTENANCE* | YES | YES |
| REPAIR COST | NO | YES |
| DEDUCTIBLE | NO | Option: €0, €190, €490 |

*the list price stated by AGCO refers solely to the extended warranty and doesn't include maintenance.

MASSEY FERGUSON OFFERS A COMPREHENSIVE AND EFFICIENT RANGE OF SERVICES

- 6,000 hrs 5 years
- 3,000 hrs 5 years
- 50,000 bales 5 years
- 6,000 hrs 5 years
- 2,000 hrs 3 years
- 25,000 bales 3 years

ISOBUS compatible machines only



YOUR COURTESY FLEET

'MF Always Running, Your Courtesy Fleet'* provides you with a temporary replacement tractor to ensure you can continue working with minimum interruption to maximise uptime while your tractor is being serviced or repaired.

We know that you can't stop until the job is done and MF Always Running ensures the need for maintenance or repairs won't stop your operations. As an MF tractor owner you will be quickly back up and running with a replacement tractor – but not just any tractor, it will be the latest model equipped to the specifications you need to get the job done.

* Please contact your local Massey Ferguson Dealer to check availability in your area. Terms and conditions apply that might vary according to the market or country. Available in the UK, Ireland, France, Germany, Italy, Spain, Poland, Norway and Denmark.

MASSEY FERGUSON 24/7 CUSTOMER HOTLINE

Your Massey Ferguson dealers are always by your side to make sure your Massey Ferguson Machine is Always Running.

In case you need any support on your machine simply call your certified service centre 24/7 on the emergency hotline. Service available in Denmark, France, Germany, Italy, Norway, Poland, Spain, UK and Ireland.

24/7 HOTLINE +800 8700 365 7



PARTS & SERVICE

IT'S ALL ABOUT A LIFETIME OF SUPPORT

Buying, owning and maintaining farm machinery can be complex, so having absolute peace of mind that you have great back-up and support is a hugely important consideration. As a Massey Ferguson customer you are assured of personalised, responsive and friendly support from our network of expert dealers who truly understand your business.

There's no cut-off time for Parts and Service because a machine may be out of service. We're available to you throughout your ownership of your Massey Ferguson machine.

We take great pride and responsibility in every machine we sell and we make it our mission to keep your machinery running reliably, every time you turn the key.

“ I want daily maintenance to be quick and easy so I can spend more time with my family. ”



THE MF 7S HAS BEEN DESIGNED TO PROVIDE FAST, STRAIGHTFORWARD, EASY AND COST-EFFECTIVE ROUTINE MAINTENANCE.

We have combined practicality with style to ensure daily maintenance is speedy, straightforward and simple, taking the stress out of maintaining your tractor, getting you to the field earlier for greater productivity and giving you some free time. With a Massey Ferguson MF 7S Series tractor, time spent in the yard preparing for the day ahead is kept to a minimum.

OPTIONS & ACCESSORIES

Today's farming demands machinery that is optimised to your business. Designed to tailor your Massey Ferguson machine to your needs, we offer a wide range of options and accessories – from loaders, weights, extra spool valves and hydraulic flowrates all the way through to auto-guidance technology. For your ultimate comfort there are seat upgrades, sound systems, drinks coolers and much more.

Everything we offer has been scrutinised by our engineers from all perspectives – optimum compatibility with your machine, safety, durability and performance. You'll get expert service from your Massey Ferguson Dealer who has all the necessary installation tools and knowledge at their fingertips.



Engine air filter is easy to access and clean.



Easy access to remove the cab air filter for cleaning.

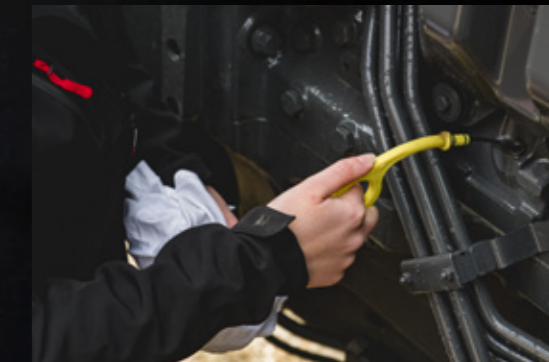

Front axle and slim waist bonnet design make oil dipstick and filter access easy.

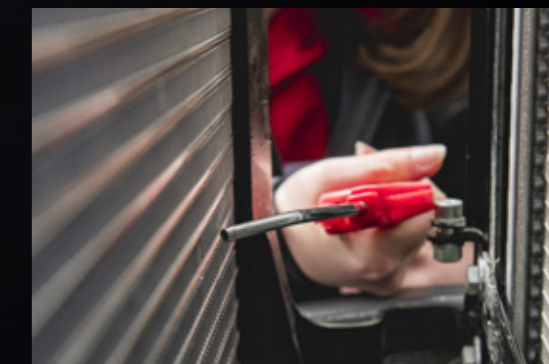

Plenty of room to access radiator for cleaning.



Filling your fuel and AdBlue® tanks has never been easier.

MFservices

ALWAYS BY YOUR SIDE TO INCREASE YOUR **PROFIT AND EFFICIENCY**

WELCOME TO MF SERVICES – EVERYTHING YOU NEED TO SUPPORT THE OPERATION OF YOUR MF 7S TRACTOR.

Accessible and adaptable, MF Services will help you control running costs, budgeting and business planning - ensuring each machine's operating hour is a success and giving you the freedom to focus fully on the core business of farming.

This comprehensive suite of service-related-products makes it easier than ever to own and operate **Massey Ferguson** farm equipment.

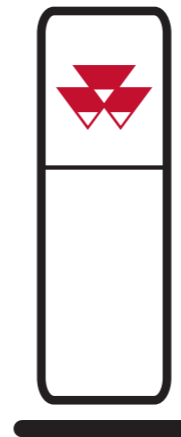

MASSEY FERGUSON DEALER NETWORK

Your MF Dealer represents the best farm machines expertise in your area. You can always turn to your dealer and receive the best service from sales, maintenance, repair and spare parts to the purchase of a new piece of equipment.

MORE THAN 4,700 SERVICE & REPAIR POINTS WORLDWIDE



MASSEY FERGUSON GENUINE PARTS

REPRESENTS THE BEST GUARANTEE OF SAFEGUARDING THE VALUE OF YOUR NEW MF 7S OVER TIME, PROTECTING IT FROM UNPLANNED DOWNTIME.

Choose from an extensive range of accessories including lubricants, AdBlue, care kits, cab accessories and much more. All accessories are available for purchase exclusively from your MF Dealer.

Using the smartphone app "AGCO Parts Books to go", you can find MF spare parts quickly and easily and order them directly. The app is available for download in the App Store and in the Google Play Store. Your personal access data is available from your MF Dealer.

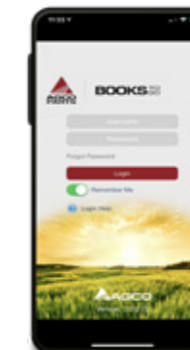

AGCO FINANCE

PROVIDES THE PERFECT FINANCING ARRANGEMENT FOR YOUR BUSINESS.

AGCO Finance is the integrated financial services arm of Massey Ferguson offering tailor-made solutions to your own farm, which includes Leasing, Loan facilities, Hire purchase, Full service packages and Contract hire including the financing of MF Care extended warranty contracts.



MASSEY FERGUSON COLLECTION

NOW YOU CAN LOOK AS STYLISH AS YOUR MASSEY FERGUSON.

Looking for a cap to match your MF 7S... Or a stylish and durable overall to keep working? We have an exclusive range of high quality products to suit you, your farming activity, your family and your lifestyle.

To find out what we have available please login into our online Shop:

Shop.MasseyFerguson.Com

For the above support packages, country terms and conditions apply. Please note all packages may not be available in all markets.

Please check with your local MF Dealer/Distributor.

MAKE THE MF 7S YOUR OWN AND AS INDIVIDUAL AS YOUR FARM



| | ESSENTIAL | EFFICIENT | EXCLUSIVE |
|---|-----------|-----------|-----------|
| ENGINE | | | |
| AGCO POWER - 6.6 litre - Stage V | ● | ● | ● |
| 'All-in-One Stage V' technology | ● | ● | ● |
| TRANSMISSION | | | |
| Power Control - Multifunction shuttle lever | ● | ● | ● |
| Right hand shuttle control | - | ● | ● |
| T-Lever on console | ● | - | - |
| A MultiPad lever on Command Control Armrest | - | ● | ● |
| Dyna-6 Super Eco 40 km/h (40 km/h @ 1,500 rpm) | ● | ● | ● |
| Dyna-6 Eco 50 km/h* (50 km/h @ 1,800 rpm) | ○ | ○ | ○ |
| Dyna-VT Super Eco 40km/h or Eco 50km/h with automatic Mode | - | ○ | ○ |
| C1 & C2 Cruise speed memories | - | ● | ● |
| Brake to Neutral - Clutch effect | ● | ● | ● |
| OPERATOR ENVIRONMENT | | | |
| Air conditioning with manual adjustment | ● | ● | ○ |
| Air conditioning with automatic control | - | ○ | ● |
| Air suspended swivel seat | ● | ● | - |
| Air suspended seat with heater and pneumatic lumbar adjustment | - | ○ | ● |
| B Automatic air suspended swivel seat, ventilated, 2 heating levels, pneumatic lumbar, longitudinal & lateral shock absorber, dual motion backrest and DDS | - | ○ | ○ |
| Mechanical cab suspension | ○ | ● | - |
| Active mechanical cab suspension | - | ○ | ● |
| FM or DAB + (Digital) Radio, CD, MP3, Bluetooth connection, USB & front auxiliary | ○ | ● | ● |
| Radio - controls in the armrest | - | ● | ● |
| C Radio & Phone interface via the Datatronic 5.9" touchscreen terminal | - | ○ | ● |
| Telescopic double angle mirrors with electric adjustment and de-icing | - | ○ | ● |
| SpeedSteer | ○ | ○ | ○ |
| Radar and slip control | ○ | ○ | ● |
| D 16 Work lights package - with daytime running LED signature | ○ | ○ | ○ |

- Not available
- Standard specification
- Optional
- * Depending on market legislation

| | ESSENTIAL | EFFICIENT | EXCLUSIVE |
|--|-----------|-----------|-----------|
| OPERATOR ENVIRONMENT | | | |
| MF TECHNOLOGIES | | | |
| MultiPad with ISOBUS implement control switch assignment | - | ○ | ● |
| MF Guide | ○ | ○ | ○ |
| E NovAtel receiver - From sub-metre to centimetre precision | ○ | ○ | ○ |
| F Trimble receiver - From sub-metre to centimetre precision | ○ | ○ | ○ |
| MF Section Control - 36 section control | ○ | ○ | ○ |
| MF TaskDoc Pro - Wireless data transfer | ○ | ○ | ○ |
| CHASSIS AND HYDRAULICS | | | |
| Front axle suspension | ○ | ● | ● |
| Mechanical control of spool valves | ● | ● | - |
| Electrical controls of spool valves | - | ● | ● |
| Electro hydraulic multifunction joystick | - | ○ | ○ |
| G Loader ready tractor with multifunction joystick (mechanical control) | ○ | - | - |
| Power Beyond with couplers | ○ | ○ | ● |
| Rear linkage with Active Transport Control | ● | ● | ● |
| Automatic PTO | ● | ● | ● |
| Mechanical PTO speed selection | ● | - | - |
| Automatic traction management (4WD & differential lock) | ● | ● | ● |
| Hydraulic top link on rear three-point linkage | ○ | ○ | ○ |
| Integrated front linkage (capacity of 3200 kg or 4000 kg depending on model) | ○ | ○ | ○ |
| Integrated Front PTO | ○ | ○ | ○ |
| CONVENIENCE | | | |
| Automatic isolator switch | ● | ● | ● |
| Standard toolbox | ● | ● | ● |
| External lift control on fenders | ● | ● | ● |
| External PTO start/stop control on fender | ● | ● | ● |
| External remote valve control on fender | - | ● | ● |
| OTHER EQUIPMENT (SPECIFICATIONS MAY VARY BY MARKET) | | | |
| Pivoting front fenders | ○ | ○ | ● |
| Pneumatic trailer brakes* | ● | ● | ● |
| Hydraulic and Pneumatic trailer brakes* | ○ | ○ | ○ |
| ABS socket dedicated to trailer brakes | ○ | ○ | ○ |



TECHNICAL SPECIFICATIONS

| ENGINE | MF 7S.155 | MF 7S.165 | MF 7S.180 | MF 7S.190 |
|--|--|-----------|----------------------------|-----------|
| Engine Type | AGCO POWER with "All-in-One" Stage V technology | | | |
| Number of cylinders/Number of valves/Capacity | No. /No./cm3 6 / 4 / 6,600 | | | |
| Aspiration | Electronic wastegate turbo and intercooler | | | |
| Injection type | Common rail | | | |
| Fan type - Transmission Dyna-6 & Dyna-VT | Vistronic | | | |
| Maximum power | 155 (114) | 165 (121) | 180 (132) | 190 (140) |
| Engine rpm at maximum power | rpm 1,950 | | | |
| Maximum torque @ 1,500 rpm | 700 | 725 | 750 | 850 |
| Maximum power with EPM | 175 (129) | 185 (136) | 210 (154) | 220 (162) |
| Maximum torque with EPM @ 1,500 rpm | 750 | 800 | 860 | 925 |
| Fuel tank capacity | Litres 305 | | | |
| AdBlue® tank capacity | Litres 30 | | | |
| DYNA-6 TRANSMISSION | | | | |
| Number of gears (Fwd x Rev) | Fwd x Rev 24 x 24 | | | - |
| Min. speed @ 1,400 rpm | km/h 1.09 | | | - |
| 40 Eco / Super Eco km/h at engine speed with max. tyre dimension | rpm 1,500 (with 650/65 R42) | | | - |
| 50 km/h* Eco at engine speed with max. tyre dimension | rpm 1,800 (with 650/65 R42) | | | - |
| DYNA-VT TRANSMISSION | | | | |
| Type | Stepless, Continuously variable transmission | | | |
| Field speed range | km/h Forward: 0.03-28 km/h - reverse: 0.03-16 km/h | | | |
| Road speed range | km/h Forward: 0.03-40 km/h - reverse: 0.03 to 38 km/h / Forward: 0.03-50 km/h - reverse: 0.03 to 38 km/h* | | | |
| REAR LINKAGE AND HYDRAULICS | | | | |
| Lower links type | Cat Cat 3 | | | |
| Maximum lift capacity, at link end | kg 7,100/8,100/9,600 | | kg 8,100/9,600 9,600 | |
| Standard hydraulic system | L/mn Load sensing 110 L/min | | | |
| Optional hydraulic system | L/mn Closed Centre Load Sensing 150 L/min or 190 L/min | | | |
| Maximum number of rear spool valves | 4/5 (Dyna-VT) | | | |

⊕ ISO 14396

- Not available

* Depending on market legislation

Every effort has been made to ensure that the information contained in this publication is as accurate and current as possible. However, inaccuracies, errors or omissions may occur and details of the specifications may be changed at any time without notice. Therefore, all specifications should be confirmed with your Massey Ferguson Dealer or Distributor prior to any purchase.

| | MF 7S.155 | MF 7S.165 | MF 7S.180 | MF 7S.190 |
|--|---------------------------------|---|-----------------------------|-------------------|
| REAR POWER TAKE-OFF | | | | |
| Engine speed at 540/1000 rpm | 1,980 / 2,030 | 1,980 / 2,030 | 1,980 / 2,030 | - |
| 540/540 Eco/1000/1000 Eco - Dyna-6 rpm | 1,980 / 1,530 / 2,030 / 1,570 | | | - |
| 540/540 Eco/1000/1000 Eco Dyna-VT rpm | 1,870 / 1,500 / 1,900 / 1,530 | | | |
| Shaft diameter | Inches 1 3/8" 6 & 21 splines | | | |
| INDEPENDANT FRONT LINKAGE AND FRONT POWER TAKE-OFF | | | | |
| Lower links type | Cat Cat 3 | | | |
| Maximum lift capacity, at link end | kg 3,200 | kg 3,200 | kg 3,200/4,000 | kg 3,200/4,000 |
| Maximum number of front spool valves | 2 | | | |
| Engine speed at 1,000 front PTO speed | 1,920 | 1,920 | 1,920 | 1,920 |
| WHEELS AND TYRES (FULL RANGE AVAILABLE. PLEASE CONSULT YOUR DEALER) | | | | |
| Front | 380/85 R28 | 420/85 R28 | 480/70 R28 | 480/70 R28 |
| Rear | 460/85 R38 | 520/85 R38 | 580/70 R38 | 580/70 R38 |
| Optional rear tyres | 710/70 R38 | 710/60 R42 - Wide choice available, contact your local Massey Ferguson Dealer | | |
| WEIGHTS (MAY VARY DEPENDING ON CONFIGURATION. PLEASE CONSULT YOUR DEALER) | | | | |
| Minimum weight / average weight / maximum weight | kg 5,800 / 7,000 / 8,150 | | kg 6,300 / 7,500 / 8,400 | |
| Maximum gross vehicle weight up to* | kg 12,500 | kg 12,500 | kg 14,000 | kg 14,000 |

* Depending on market legislation

DIMENSIONS

| | MF 7S Dyna-6 | MF 7S Dyna-VT |
|---|--------------|---------------|
| A Wheelbase | m 2.88 | m 2.88 |
| B Overall length from front linkage to rear linkage arms | mm 5,604 | mm 5,604 |
| B Overall length from front weight frame to rear linkage arms | mm 4,928 | mm 4,928 |
| C Height at centre of rear axle to top of cab | mm 2,110 | mm 2,144 |
| D Total height | mm 2,985 | mm 3,019 |





www.MasseyFerguson.co.uk

www.facebook.com/masseyfergusonUK

[Twitter.com/MF_EAME](https://twitter.com/MF_EAME)

[Instagram.com/MasseyFergusonGlobal](https://www.instagram.com/MasseyFergusonGlobal)

www.YouTube.com/MasseyFergusonGlobal



MASSEY FERGUSON® is a worldwide brand of AGCO.
© AGCO Corporation | A-A-17317 | English



MASSEY FERGUSON